

DL-EASY APP 38

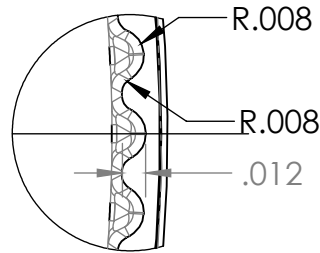
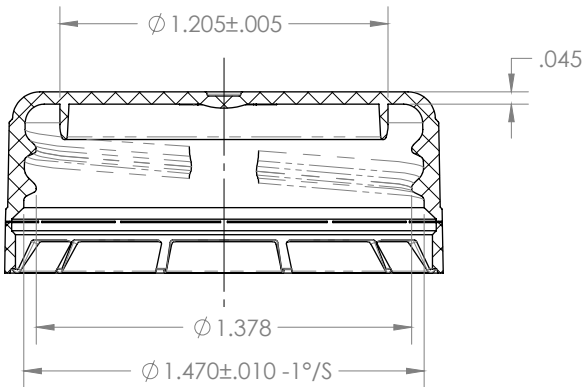

MARKETS

- Food and Beverage

PRODUCT APPLICATIONS

- Hot Fill / Cold Fill Tea
- Hot Fill / Cold Fill Juice
- Vitamin Water
- Non-Carbonated Beverages

ADVANTAGES

- Easy Application
- Linerless Plug Seal Design
- Excellent Tamper Evidence
- Total Band Separation

CLOSURE SPECS

- Weight: 3.4gms
- Diameter: 38mm
- Height: 16.85mm

DISC LINING MATERIAL OPTION

- SS-222 Foam
- EVA
- Foil Induction Seal

NECK FINISH

- Double Lead PCF-38P-1 Vented

CLOSURE SEAL OPTION

- Linerless Plug Seal
- Disc Liner

BOTTLE TYPE

- Glass
- PET
- HDPE

RESIN TYPE

- PP
- HDPE

FILLING PROCESS

- Cold Fill
- Ambient
- Hot Fill

CAP PACKING SPECS (PIECES)

- Carton: 1,872
- Pallet: 39,312 (3 layers)
- Truck Load: 2,358,720 (60 pallets)
- Carton: 19.25 x 12.75 x 14.5



RIGID